

300 Series

Available in these Types:
F - Flat top
C - Contour

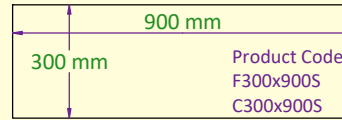

Product Codes
F300x900S
C300x900S

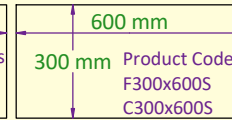

Product Codes
F300x600S
C300x600S



Product Codes
F300x915C
C300x915C

450 Series

Available in these Types:
F - Flat top
C - Contour

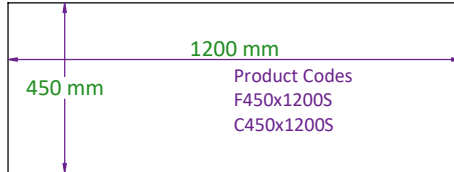

Product Codes
F450x1200S
C450x1200S

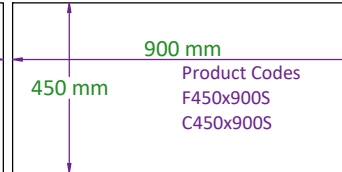

Product Codes
F450x900S
C450x900S

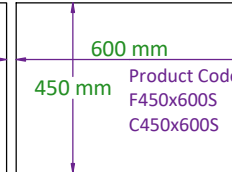

Product Codes
F450x600S
C450x600S

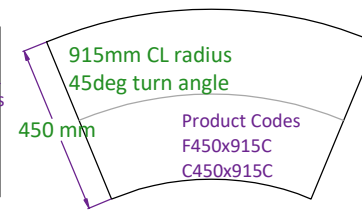

Product Codes
F450x915C
C450x915C

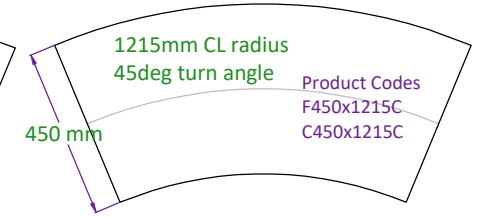

Product Codes
F450x1215C
C450x1215C

600 Series

Available in these Types:
F - Flat top
C - Contour

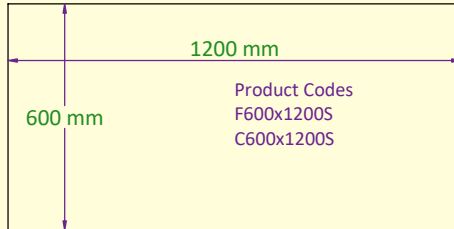

Product Codes
F600x1200S
C600x1200S

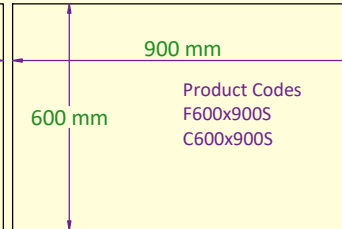

Product Codes
F600x900S
C600x900S

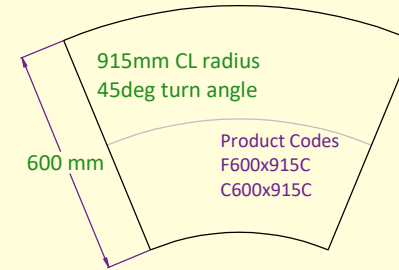

Product Codes
F600x915C
C600x915C

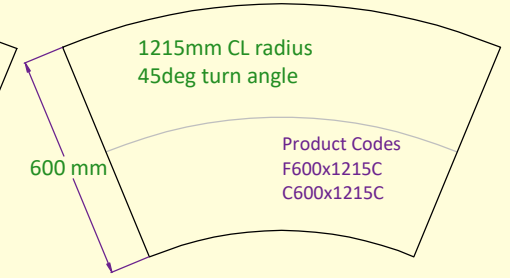

Product Codes
F600x1215C
C600x1215C

750 Series

Available in these Types:
F - Flat top
C - Contour

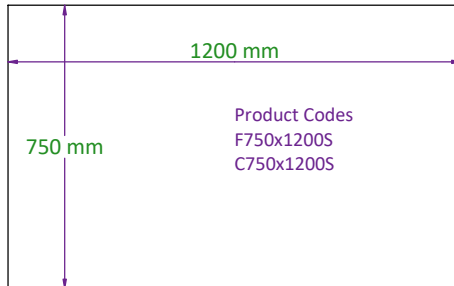

Product Codes
F750x1200S
C750x1200S

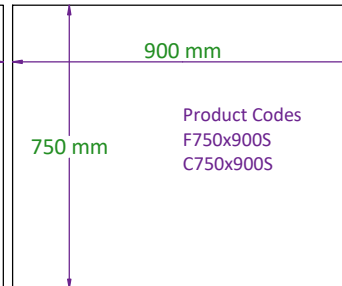

Product Codes
F750x900S
C750x900S

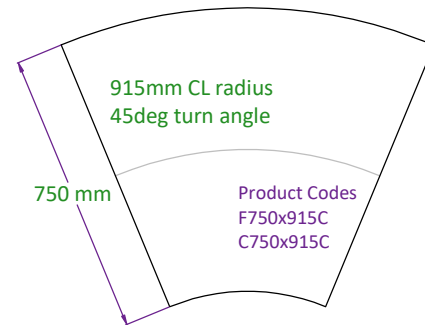

Product Codes
F750x915C
C750x915C

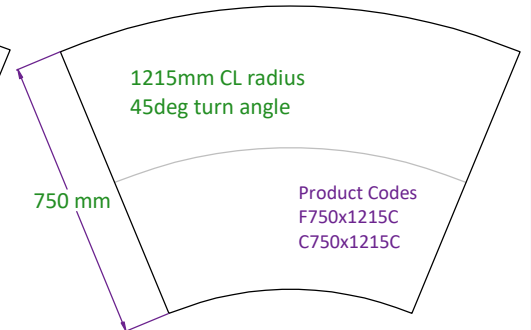

Product Codes
F750x1215C
C750x1215C

Supplied as a flat-pack kit for your assembly



Standard Size and Shape Baseboards

300, 450, 600 and 750 Series, F and C Type

Model Layout Services

www.modellayoutservices.co.uk 07976 217624

DRG RangeGuide_v23-1_1

Rev -